

Operating Instructions

Version 2.0



HYDROMETTE

BL COMPACT B 2



EN



GANN MESS- U. REGELTECHNIK GMBH

70839 GERLINGEN

SCHILLERSTRASSE 63

INTERNET: <http://www.gann.de>

Verkauf National: TELEFON 07156-4907-0
Verkauf International TELEFON +49 7156-4907-0

TELEFAX 07156-4907-40
TELEFAX +49 7156-4907-48

EMAIL verkauf@gann.de
EMAIL sales@gann.de

Disclaimer

GANN Mess- u. Regeltechnik GmbH does not make any assurances or warranties with respect to this document and, to the extent permitted by law, limits its liability for breach of any implied warranty to the replacement of this document with another. Furthermore, GANN Mess- u. Regeltechnik GmbH reserves the right to revise this publication at any time without having to notify anyone about such revisions.

The information provided in this documentation includes general descriptions and/or technical characteristics for the performance of the equipment described herein. This documentation cannot be used as a proper assessment of the suitability or reliability of the equipment for a specific application by a user and must not be used as a substitute for such an assessment. It is the responsibility of any such user to carry out an appropriate and complete risk assessment, evaluation and testing of the equipment with regard to his specific application. Neither GANN Mess- u. Regeltechnik GmbH nor any of its partner or subsidiary companies can be made responsible or liable in the event of misuse of the information contained in this document.

All relevant national, regional and local safety regulations must always be observed when installing and using this device. For reasons of safety and to ensure compliance with the documented system data, only the manufacturer is authorised to carry out repairs to components. Failure to observe this information may result in injury or damage to the equipment.

Copyright © 2024 GANN Mess- u. Regeltechnik GmbH, Gerlingen

All rights reserved. No part of this publication may be reproduced, processed or distributed in any form, including photocopying, recording or any other electronic or mechanical process, without the written permission of the publisher. Requests for permissions must be made in writing to the publisher at the address given on the title page.



Table of Contents

| | | |
|-------|---|----|
| 1 | Foreword | 5 |
| 1.1 | User Description | 5 |
| 1.2 | Intended Use | 5 |
| 1.3 | Non-Intended Use | 5 |
| 1.4 | Explanation of the General Warnings | 6 |
| 1.5 | General Safety Instructions | 7 |
| 1.5.1 | Persons at Risk..... | 7 |
| 1.5.2 | Preparation and Start-up..... | 8 |
| 1.5.3 | Use / Operation | 8 |
| 1.5.4 | Care, Maintenance and Inspection | 9 |
| 1.5.5 | Troubleshooting | 9 |
| 1.5.6 | Disposal | 9 |
| 2 | Specifications..... | 10 |
| 2.1 | Technical Data | 10 |
| 2.2 | Prohibited Environmental Conditions | 10 |
| 2.3 | Transport- & Storage Conditions..... | 10 |
| 2.4 | Measuring Range..... | 11 |
| 3 | General Information..... | 12 |
| 3.1 | Standards and Directives..... | 12 |
| 3.2 | Warranty..... | 12 |
| 4 | Description of the Product | 13 |
| 5 | Device Layout and Button Assignment | 14 |
| 5.1 | Display Symbols..... | 15 |
| 5.1.1 | Main Menu Symbols..... | 15 |
| 5.1.2 | Other Symbols | 15 |
| 5.2 | Switching the Device On and Off..... | 16 |
| 5.3 | Setting Menus..... | 16 |
| 5.3.1 | Measuring Menu (Main Menu) | 17 |
| 5.3.2 | Material Setting..... | 18 |
| 5.3.3 | Alarm Value Setting..... | 19 |
| 5.3.4 | Maximum Value Display..... | 20 |
| 5.3.5 | Memory Menu..... | 21 |
| 6 | Other Functions..... | 22 |
| 6.1 | Automatic Switch-Off | 22 |

| | | |
|------|--|----|
| 6.2 | Battery Monitoring..... | 22 |
| 6.3 | Querying the Device Firmware..... | 22 |
| 7 | Installation of the PC-Software GANN Dialog Pro..... | 23 |
| 8 | USB-Communication with a PC..... | 25 |
| 9 | Application Notes..... | 26 |
| 9.1 | Comparative Measurement or Reference Measurement..... | 26 |
| 9.2 | General Notes on Structural Moisture Measurement..... | 27 |
| 9.3 | Notes on non-destructive Structural Moisture Measurement..... | 28 |
| 9.4 | Using the Hydromette BL Compact B 2..... | 29 |
| 9.5 | Display Values (Digits) in Relation to the Bulk Density..... | 32 |
| 9.6 | Orientation Values..... | 33 |
| 10 | Accessories..... | 33 |
| 11 | Appendix..... | 34 |
| 11.1 | Material Table..... | 34 |
| 11.2 | Display Values (Digits) by Weight Percentage or CM Percentage..... | 34 |
| 11.3 | General Concluding Remarks..... | 35 |
| 12 | EU Declaration of Conformity..... | 36 |



1 Foreword

1.1 User Description

These instructions are intended for the end user of the product. The end user of the product is a person who has read and understood these operating instructions, is an experienced user of similar devices and is aware of all possible dangers and can act accordingly.

The device may only be used by persons aged 14 and over who have read and understood these operating instructions, are familiar with the operation of similar products and are aware of all possible dangers and act accordingly.

The device is intended for use by persons who have experience with moisture measurements (structural moisture, wood moisture, climate, etc.).

All personnel involved in the operation, installation, inspection and maintenance of the product must be qualified to carry out the associated work. If the personnel concerned do not already have the required knowledge and skills, appropriate training and instruction must be ensured.

All local regulations must be observed.

1.2 Intended Use

The BL Compact B 2 unit is an electronic structural moisture indicator for non-destructive building material moisture measurement.

The measuring instrument uses the dielectric constant/radio frequency measuring principle. This non-destructive measurement technology is used to detect moisture distribution in walls, ceilings and floors.

The Hydromette BL Compact B 2 may only be used for structural moisture measurements.

1.3 Non-Intended Use





The device is not intended for any applications that are not listed in these operating instructions.

The device, accessories, tools, software, etc. must be used in accordance with these instructions, taking into account the working conditions and the work to be performed. Using the product for work other than that for which it is intended will result in a hazardous situation.

The device may only be used together with the original accessories. The device must only be used within the specified performance limits as described in these instructions.

1.4 Explanation of the General Warnings

The following danger levels are used in this operating manual to indicate potentially dangerous situations and important safety instructions:

| Danger Level | Description |
|---|--|
|  DANGER | Danger / Indicates a hazardous situation which, if not avoided, will result in death or serious irreversible injuries. |
|  WARNING | Warning / Indicates a hazardous situation which, if not avoided, could result in death or serious irreversible injuries. |
|  CAUTION | Caution / Indicates a hazardous situation which, if not avoided, could result in minor or moderate injuries. |
|  INFORMATION | Indicates important information. |

1.5 General Safety Instructions

It must be ensured that the complete instructions and all safety instructions have been read and understood before using this device.

All instructions must be followed. This prevents accidents that can result in property damage or minor or moderate injuries.



All safety information and instructions must be kept for future reference and passed on to subsequent users of the product.

INFORMATION

The manufacturer shall not be liable for any damage to property or injuries to persons that can be attributed to incorrect handling or non-compliance with the safety instructions. In such cases, the warranty shall be void.

1.5.1 Persons at Risk

Persons with reduced physical, sensory or mental capabilities or lack of experience and knowledge must be supervised or instructed in the safe use of the device and understand the associated hazards.

Children must be supervised to ensure that they do not play with the device. The device is not a toy. There is a risk of swallowing small parts of the device (e.g. battery compartment cover) or an accessory (e.g. TF-Stick, not for all BL device types).

This device is not intended for use by persons with reduced physical, sensory or intellectual capabilities, or lack of experience and/or knowledge.



WARNING

Risk of suffocation, injury or permanent disability. The device must not be used by persons under the age of 14!

Risk of suffocation! Keep packaging away from children.

1.5.2 Preparation and Start-up

Never store or place the device in a location where it can fall or be drawn into water or other liquids.

To avoid the risk of electric shock, never immerse the device in water or other liquids.

Always remove all packaging before operating the device.



WARNING

Fire hazard!
Do not use a damaged device.

In the event of visible damage, strong odours or excessive heating of components, the battery must be removed immediately and the appliance must not continue to be used.

1.5.3 Use / Operation



CAUTION

Risk of damage. The device is a highly sensitive measuring instrument.
Only use the device in a controlled electromagnetic environment.

Do not let the device drop onto hard surfaces. This can result in malfunctions or functional failures. Normal use of the device, without excluding hazards to the user, cannot be guaranteed.

The device is fragile.

To avoid overheating, the device must not be covered or used near heat sources or direct sunlight and only be used at ambient temperatures between 0 °C and 40 °C.

The device may not be stored or operated in aggressive atmospheres or atmospheres containing solvents!

The measuring device may be operated in residential and commercial areas.

Measurements **must not** be carried out on conductive surfaces.

Static charge - At low humidity levels, static electricity with high voltage can build up, favoured by external circumstances (friction during material transport, high insulation value of the surrounding area), which can lead to strong fluctuations in measured values. Even the instrument operator may - inadvertently - contribute to the build-up of a static charge by the clothing worn. A considerable improvement can be achieved by the operator and the measuring instrument being absolutely still during measuring, as well as by earthing (contact with conducting metal, water or heating pipes, etc.).

1.5.4 Care, Maintenance and Inspection



CAUTION

Remove the battery before cleaning the product. Do not use abrasive cleaning cloths or chemicals to clean the product as these can damage the surface.

Stop using the product in the case of visible damage, strong odour development or excessive overheating of components.

Only use original accessories.

Changes to the device and technical modifications are not permitted without the written consent of the manufacturer.

All connection options and the device itself must not be sprayed directly or indirectly with water when cleaning (connections depend on the device! e.g. BNC-, 2.5 mm, 3.5 mm jack receptacle and mini-USB port).

Our recommendation: To ensure functionality, have all your measuring equipment checked by the manufacturer every 2–3 years (depending on the frequency of use).

1.5.5 Troubleshooting

Do not repair the device yourself. Contact the manufacturer if the device is not functioning properly.

1.5.6 Disposal

Electrical equipment, accessories and packaging must not be disposed of together with household waste (only for EU countries) and must be disposed of in compliance with the European Directive 2012/19/EU on waste electrical and electronic equipment and its implementation in accordance with national law. Electrical equipment that has reached the end of its service life must be collected separately and sent to an environmentally compatible recycling facility.

The WEEE symbol draws attention to the need for disposal.

The device contains a battery. Batteries must not be disposed of with normal household waste. They may contain toxic heavy metals and are subject to the hazardous waste ordinance. For this reason, dispose of the battery at a local collection point for the recycling of waste electrical and electronic equipment. Caution, there is a risk of explosion if the wrong type of battery is inserted. Handle used batteries according to the manufacturer's instructions.

Gann Mess- u. Regeltechnik GmbH accepts no liability for damage caused by non-compliance with the operating instructions or by violation of a duty to care during transport, storage or operation of the instrument, even if this duty to care is not specifically discussed in the operating instructions.

2 Specifications

2.1 Technical Data

Hydromette

| | |
|-------------------------|--|
| Display: | LCD segment display with three lines |
| Display resolution: | 0.1% for humidity 0.1 digits in scan mode |
| Response time: | < 2 s |
| Storage conditions: | + 5 to + 40 °C - 10 to + 60 °C (for a short time) |
| Operating conditions: | 0 to + 50 °C - 10 to + 60 °C (for a short time) < 85 % R.H. non-condensing |
| Power supply: | 9-V-block battery |
| Types that can be used: | Types 6LR61 and Type 6F22 |
| Dimensions: | 225 x 50 x 30 (L x W x H) mm |
| Weight: | approx. 180 g |
| Protection class: | III |
| Protection rating: | IP20 |

2.2 Prohibited Environmental Conditions

- Condensation. humidity continuously too high (> 85% R.H.) and wetness
- Permanent presence of dust and combustible gases. vapours or solvents
- Ambient temperatures continuously too high (> +50 °C)
- Ambient temperatures continuously too low (< 0 °C)

2.3 Transport- & Storage Conditions

Die Hydromette BL Compact B 2 may **only be stored in the packaging provided by the manufacturer or available from the manufacturer as an accessory**. The manufacturer shall not accept any liability or warranty for damage that may occur to the device or to the sensor system as a result of non-compliance.



INFORMATION

In particular, **avoid keeping or storing the devices in foams not supplied by the manufacturer**, as these can damage the sensors due to possible outgassing and result in incorrect measurements.

2.4 Measuring Range

Scan mode: 0 to 200 digits

Building material characteristic:

| | | | |
|-------------------|-------------------------|-----|------------------|
| Cement screed: | 1.8 to 5.9 % by weight | and | 0.7 to 4.0 CM-% |
| Anhydrite screed: | 0.1 to 3.3 % by weight | and | 0.1 to 3.3 CM-% |
| Concrete: | 1.3 to 6.2 % by weight | and | 0.3 to 4.2 CM-% |
| Cement mortar: | 1.8 to 7.8 % by weight | and | 0.6 to 5.6 CM-% |
| Lime mortar: | 0.6 to 4.5 % by weight | and | 0.6 to 4.5 CM-% |
| Mixed plaster: | 2.2 to 11.0 % by weight | and | 1.5 to 10.0 CM-% |
| Gypsum plaster: | 0.3 to 10.0 % by weight | and | 0.3 to 10.0 CM-% |

3 General Information

3.1 Standards and Directives

This measuring instrument fulfils the requirements of the applicable European and national directives (2014/30/EU) and standards (EN 61010). Appropriate declarations and documentation are held by the manufacturer.

To ensure trouble-free operation of the measuring instrument and operational reliability, the user must carefully read and understand the operating instructions.

3.2 Warranty

The measuring instrument may only be operated under the specified climatic conditions. These are listed in [chapter 2.1 "Technical Data](#) of the Hydromette".

This measuring instrument may only be used under the conditions and for the purposes that it has been designed for. Operational reliability and functionality are no longer ensured if the device is modified or adapted. Gann Mess- u. Regeltechnik GmbH shall not be liable for any damage arising from such modifications or adaptations. The risk is borne solely by the user.

The measuring instrument and any accessories may only be properly used as described in these instructions. Keep the device and accessories out of the reach of children!

The device must not be stored or operated in air that is corrosive or contains solvents!

The notes and tables in these instructions regarding permitted or normal humidity conditions in practice and the general definitions of terms have been taken from the specialist literature. Therefore, the manufacturer cannot guarantee the correctness. The conclusions to be drawn from the measurement results depend for each user on the individual circumstances and the knowledge gained from his professional experience.

The measuring instrument may be used in the residential and commercial sectors.

The measuring instrument may only be stored in the packaging provided by the manufacturer or available from the manufacturer as an accessory. The manufacturer accepts no liability for damage that may occur to the device or the sensor system as a result of non-compliance.

Gann Mess- u. Regeltechnik GmbH accepts no liability whatsoever for damage caused by non-compliance with the operating instructions or by breach of the duty of care during transport, storage and handling when operating the device, even if this duty of care is not specifically referred to in the operating instructions.

4 Description of the Product

The BL Compact B 2 unit is an electronic **structural moisture indicator** for non-destructive building material moisture measurement. The Hydromette unit uses the dielectric constant / radio frequency principle of measurement. The versatile ball sensor is used to **sense moisture in building materials** of any kind as well as to **determine the moisture distribution** in walls, ceilings, and floors.

An ideal pre-tester for all CM devices, resistance measuring devices and other material-destroying measuring methods.

The characteristic curves stored in the device for various construction materials allow the measured values to be displayed directly in per cent by weight (wt. %).

A limit value can be set individually for each building material, and an **acoustic warning signal sounds** if this is exceeded.

An internal memory is available for storing data (max and hold function).

The Hydromette BL Compact B2 has a 3-line LCD display. The silicone buttons give haptic feedback for important functions.

The measuring instrument has a mini-USB port that can be used to download any firmware updates using the free GANN Dialog Pro PC software.

5 Device Layout and Button Assignment



Figure 5-1: View of the Hydromette BL Compact B 2

5.1 Display Symbols

5.1.1 Main Menu Symbols

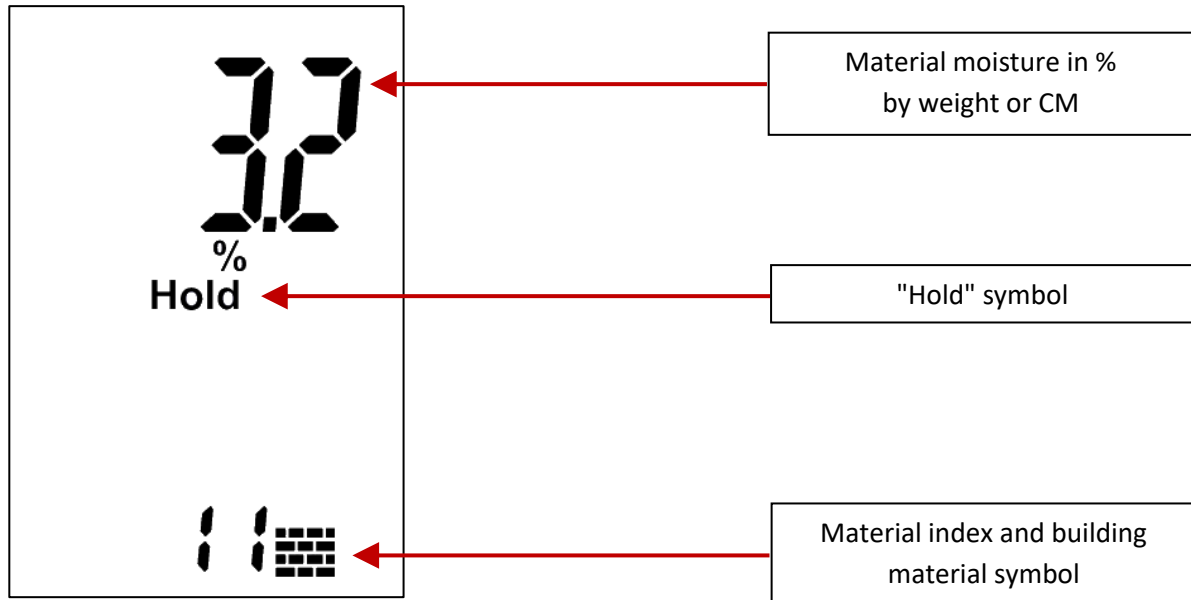

Figure 5-2: Main menu symbols

5.1.2 Other Symbols

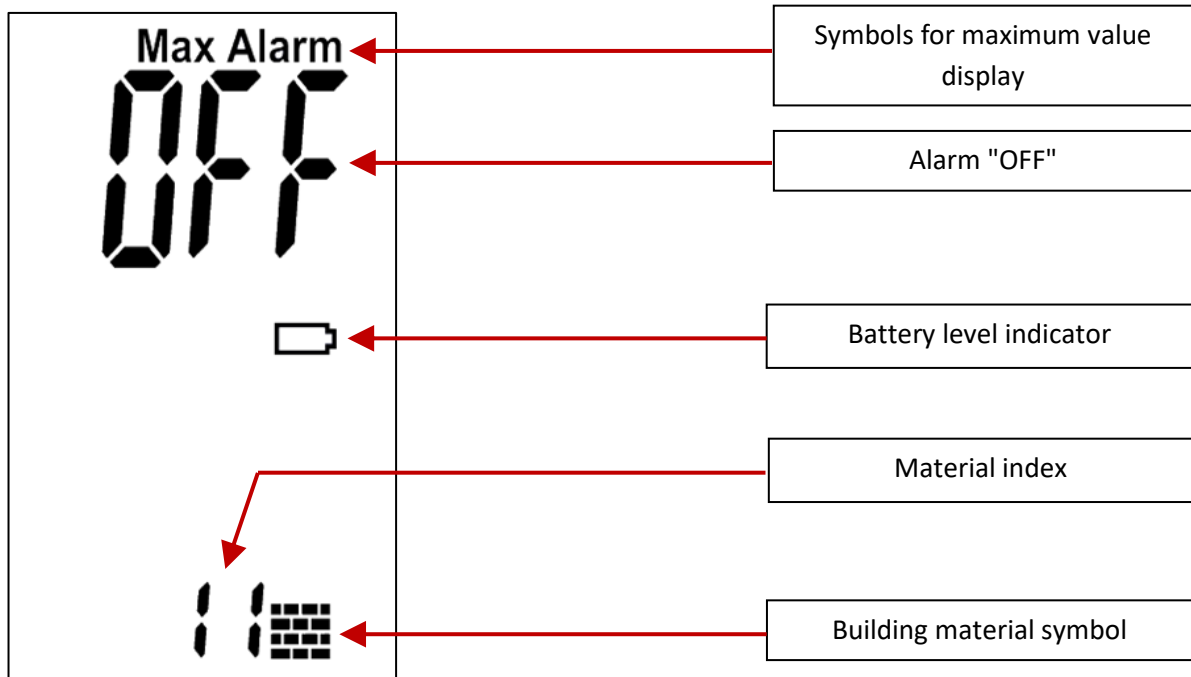



Figure 5-3: Other symbols

5.2 Switching the Device On and Off

The device is switched on and off by pressing the "On / Off" button . The device starts in the measuring menu or main menu. The measuring process can be carried out here [[see Chapter 5.3.1 "Measuring menu \(main menu\)"](#)].

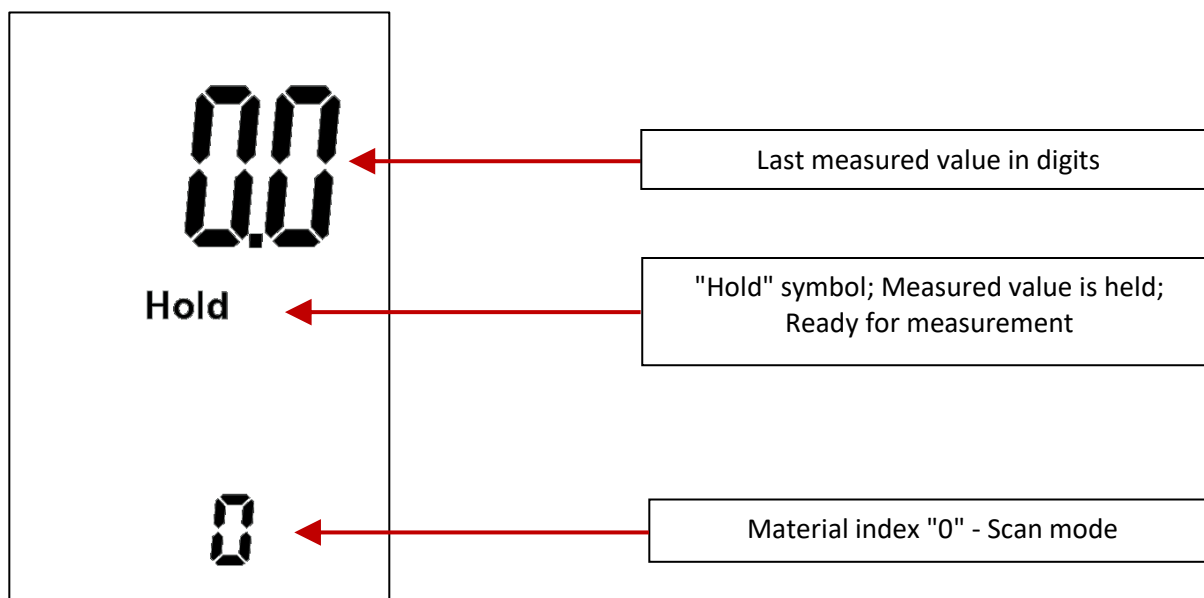

Figure 5-4: Scan mode display

5.3 Setting Menus

The following menu items can be selected one after the other by repeatedly pressing the "Down" button:

1. **Measuring Menu** (main menu): The measuring process can be performed here.
2. **Material setting**: The material can be selected here.
3. **Alarm value setting**: A measured value threshold can be set here, above which an acoustic signal sounds.
4. **Maximum value display**: The largest measured value is shown here.
5. **Memory Menu**: The last 5 measured values are stored here. The oldest value is overwritten after each measurement.

The menu items are selected in reverse order by pressing the "Up" button.

5.3.1 Measuring Menu (Main Menu)

After switching on, the device is in the measuring menu (main menu). The other menus can be accessed from here by pressing the "**Up**" or "**Down**" buttons.

In the measurement menu, the last measured values are displayed according to the material selection with the corresponding units (not for material code "0" / scan mode) and the note "**Hold**".

Measurements are taken by placing the ball electrode on the material to be measured. A new measurement is started by pressing the "**M**" button (*> 2 seconds*).

During the measuring process, the "**Hold**" symbol disappears from the display. After releasing the "**M**" button, the measured value is held and automatically stored in the ring memory. This overwrites the oldest stored value. The "**Hold**" symbol is displayed again.

If the new measured value is larger than the previous maximum value, "**Max**" flashes on the display. If the new value should be accepted, the "**M**" button must be pressed briefly (*< 1 second*). If the value should not be saved, a new measurement can be started by pressing and holding (*> 2 seconds*) the "**M**" button without changing the previous maximum value.

If the **alarm function** is turned on (see [chapter 5.3.3. Alarm value setting](#)), a warning signal sounds if the adjustable alarm value is exceeded. At the same time, the selected alarm value is shown in the second line of the display.

If the measuring range of a selected material is exceeded or not reached, a flashing measured value warns you, which is also marked alternately with "**LO**" or "**HI**" (not for material code "0" / scan mode).

By default, the Hydromette BL B2 is supplied with the material code "0" (scan mode) as the factory setting.

The **material index "0"** stands for a measurement in digits. The scaling is then in the range of 0–200 digits. The % symbol and the material symbol disappear. This value allows you to quickly scan larger areas for the maximum moisture or the extent of moisture damage.



INFORMATION

Digital values are dimensionless measurement values and not real moisture values as a percentage! For this reason, the measurement values are displayed in digits WITHOUT %!

5.3.2 Material Setting



The material can be selected in this menu. Please refer to the [material table](#) in Chapter 11.1 in the appendix for the corresponding material data.

The set material index and the building material symbol are displayed (the building material symbol does not appear for material code number "0" / scan mode).

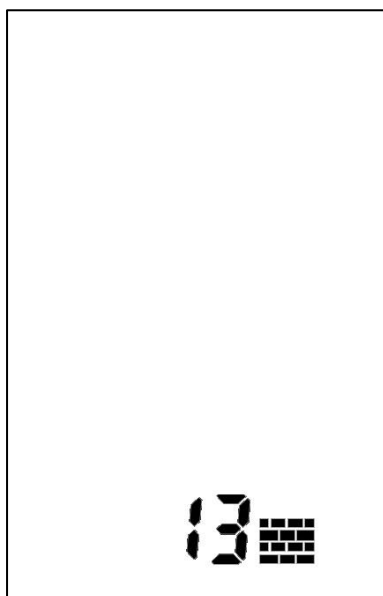

To be able to make the material settings, the device must be switched on and in the measurement menu (main menu). Then press the "Down" button once to access the material settings. If you now want to change the setting for the material, press the "M" button briefly (< 1 second).

The measuring mode display flashes and can be set using the Up and Down buttons. The change is saved by briefly (< 1 second) pressing the "M" button again.

Figure 5-5: Display of material setting menu

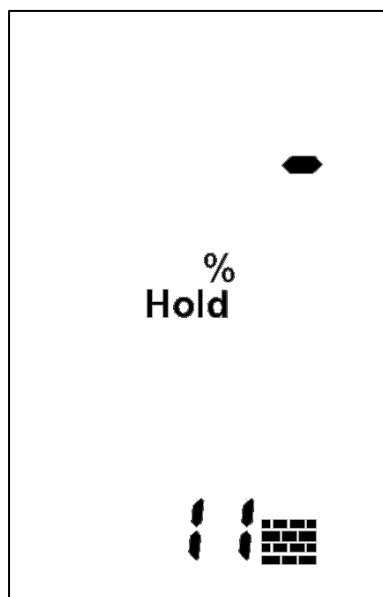

After confirming the change, the display automatically jumps to the measuring menu of the (newly) selected material. This removes the values of the previous material from the display. Any stored "Max" values remain in the memory of the respective measuring mode.

Now a new measurement can be performed by pressing and holding (> 2 seconds) the "M" button.

Figure 5-6: Display after a material change

5.3.3 Alarm Value Setting



The alarm function can be activated or deactivated in this menu. The alarm value can also be set. If the set alarm value is exceeded, an acoustic signal sounds.

The "Alarm" symbol, the set alarm value and the corresponding material index and material symbol are displayed.

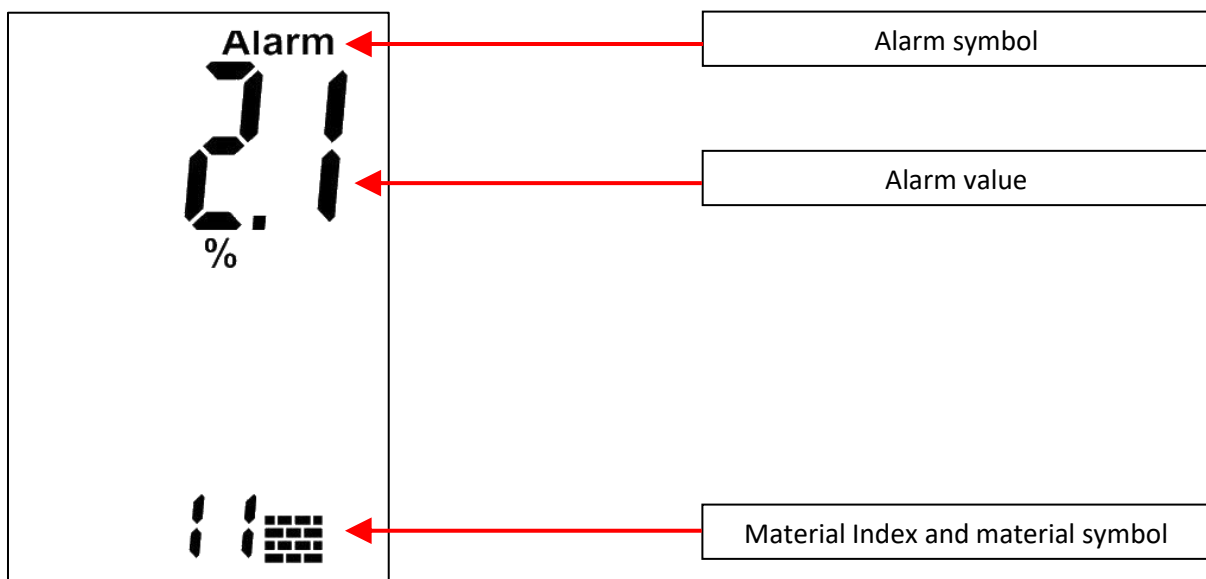

Figure 5-7: display alarm value

The alarm function is set to "OFF" as the factory setting.

If you want to activate the function or enter a new alarm value. press the "M" button briefly (< 1 second). The "OFF" display starts to flash.

A long (> 1 second) press on the "M" button activates the alarm value. The alarm value can be set separately for each material index set in measuring mode using the "Up" and "Down" buttons. As a factory setting, the maximum measuring range value is assigned to each material index as the alarm value. The default setting for material code number "0" is 80 digits.

If the desired value has been set or an existing value has been (re-)activated, the entry must be confirmed by briefly (< 1 second) pressing the "M" button. The instrument returns to the measuring mode.

If 0 is chosen as the material ID, the display will show in digits, without percentage data.

5.3.4 Maximum Value Display



The highest measured value of a measurement series is displayed together with the "Max" display symbol.

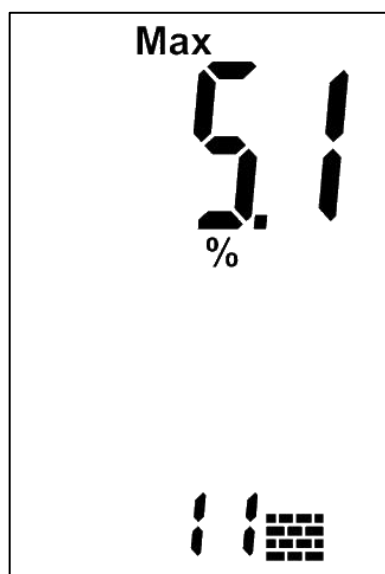

Figure 5-8: Maximum value display

A dash at the position of the measured value indicates that there is no maximum value (yet).

If an existing maximum value should be deleted, the displayed value must be selected by *briefly (< 1 second)* pressing the "M" button.

The value flashes and can now be deleted by pressing and holding (*> 1 second*) the "M" button. A dash at the position of the measured value indicates the successful deletion of the value.

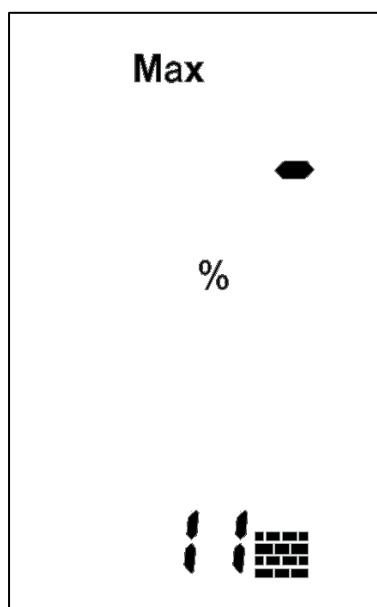

Figure 5-9: Deleted maximum value

The device returns to the measuring mode by *briefly (< 1 second)* pressing the "M" button again.

A new measurement can then be performed immediately by pressing and holding (*> 2 seconds*) the "M" button.

5.3.5 Memory Menu



The ring memory symbol "o" and the corresponding memory location number are displayed.

As soon as you select the memory menu, the memory location number "o1" is displayed for approx. 1 second, and then the last measured saved value contained there is displayed.

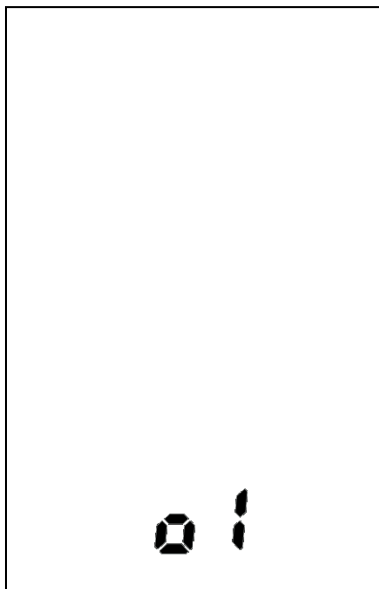

Figure 5-10: Memory location "o1"

As soon as you select the memory menu, the memory location number "o1" is displayed for approx. 1 second, and then the last measured saved value contained there is displayed.

By briefly (< 1 second) pressing the "M" button, the next memory location "o2" can be selected and the value it contains displayed.

The last 5 measured values are automatically saved and stored in the memory locations "o1" – "o5". The last measured value is in memory location "o1". The memory is designed as a ring memory. As soon as a sixth measured value is recorded, the oldest measured value in memory location "o5" is automatically removed from the memory.

After reaching the 5th memory location, the value of the 1st memory location is displayed again. Manual deletion of a memory value is not possible.

If the "M" button is pressed (and held) *for longer than 2 seconds*, the display of the memory value vanishes, only the memory location number is displayed. This signals that the user is still in the Memory Menu and not in the Measuring Menu. The memory value is retained in the background.

The saved values displayed can be identified by the fact that there is **no "Hold" symbol** in the display.

6 Other Functions

6.1 Automatic Switch-Off

If no button is pressed within approx. 90 seconds, the device switches off automatically. The current values are retained and are displayed again after the device is switched on again.

6.2 Battery Monitoring

If the battery symbol  is shown in the display, the battery is dead and must be replaced. A list of battery types that can be used can be found in chapter [„2.1 Technical Data“](#).

The device serial number is also located in the battery compartment.



INFORMATION

Under no circumstances should you use the mini-USB interface to charge an empty battery – the device does not have a charging circuit. It is only supplied with the typical USB voltage. No measurements are possible when the USB connection is plugged in.

6.3 Querying the Device Firmware

To query the firmware version of the device, the "Down" button (∇) and the "Up" button (Δ) must be pressed simultaneously for approx. 2 seconds when the device is switched on. A "V" appears in the first line of the display, the firmware version number in the second line and a specific ID number (device-dependent) in the third line.

Briefly press the "M" button to return to measuring mode.

7 Installation of the PC-Software GANN Dialog Pro

The system requirements for the PC software GANN Dialog Pro are as follows:

- Operating system Windows 7 / Windows 8 / Windows 10 / Windows 11
- 2 GB free hard disk space
- 4 GB RAM memory
- USB-port
- Minimum screen resolution 1280 x 800 (1920 x 1080 is recommended)
- Internet connection for software downloads, updates and upgrades

The PC software GANN Dialog Pro is available for download free of charge at the following link:

<http://download-ota.gann.de/dlg>

Detail information about the PC software GANN Dialog Pro can be found in the associated user manual.

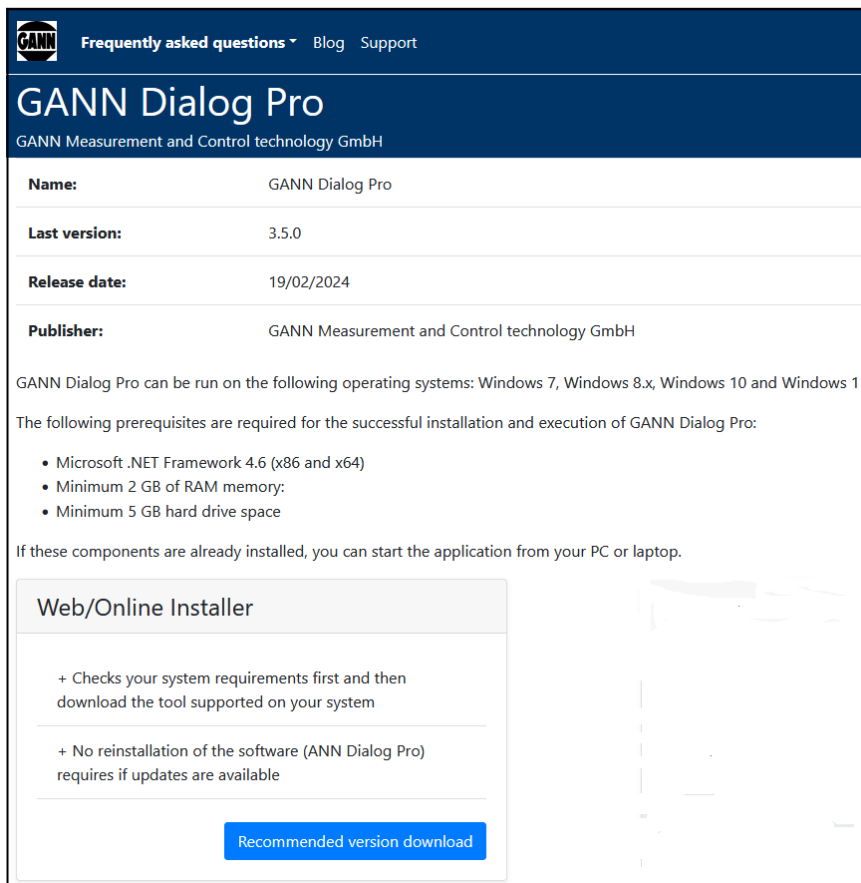

The screenshot shows the GANN Dialog Pro software page. At the top, there is a navigation bar with the GANN logo and links for 'Frequently asked questions', 'Blog', and 'Support'. Below this is a dark blue header with the text 'GANN Dialog Pro' and 'GANN Measurement and Control technology GmbH'. The main content area features a table with the following information:

| | |
|----------------------|--|
| Name: | GANN Dialog Pro |
| Last version: | 3.5.0 |
| Release date: | 19/02/2024 |
| Publisher: | GANN Measurement and Control technology GmbH |

Below the table, it states: 'GANN Dialog Pro can be run on the following operating systems: Windows 7, Windows 8.x, Windows 10 and Windows 11.' It then lists prerequisites for installation and execution:

- Microsoft .NET Framework 4.6 (x86 and x64)
- Minimum 2 GB of RAM memory:
- Minimum 5 GB hard drive space

It also notes: 'If these components are already installed, you can start the application from your PC or laptop.'

The bottom section is titled 'Web/Online Installer' and lists two benefits:

- + Checks your system requirements first and then download the tool supported on your system
- + No reinstallation of the software (ANN Dialog Pro) requires if updates are available

A blue button labeled 'Recommended version download' is positioned at the bottom of this section.

Figure_7_1: Download of the PC software GANN Dialog Pro

If you click on the "Download recommended version" button, you will be asked whether you want to download the software. Confirm this with "Save file" to start the download. Perform the installation steps of setup.exe.

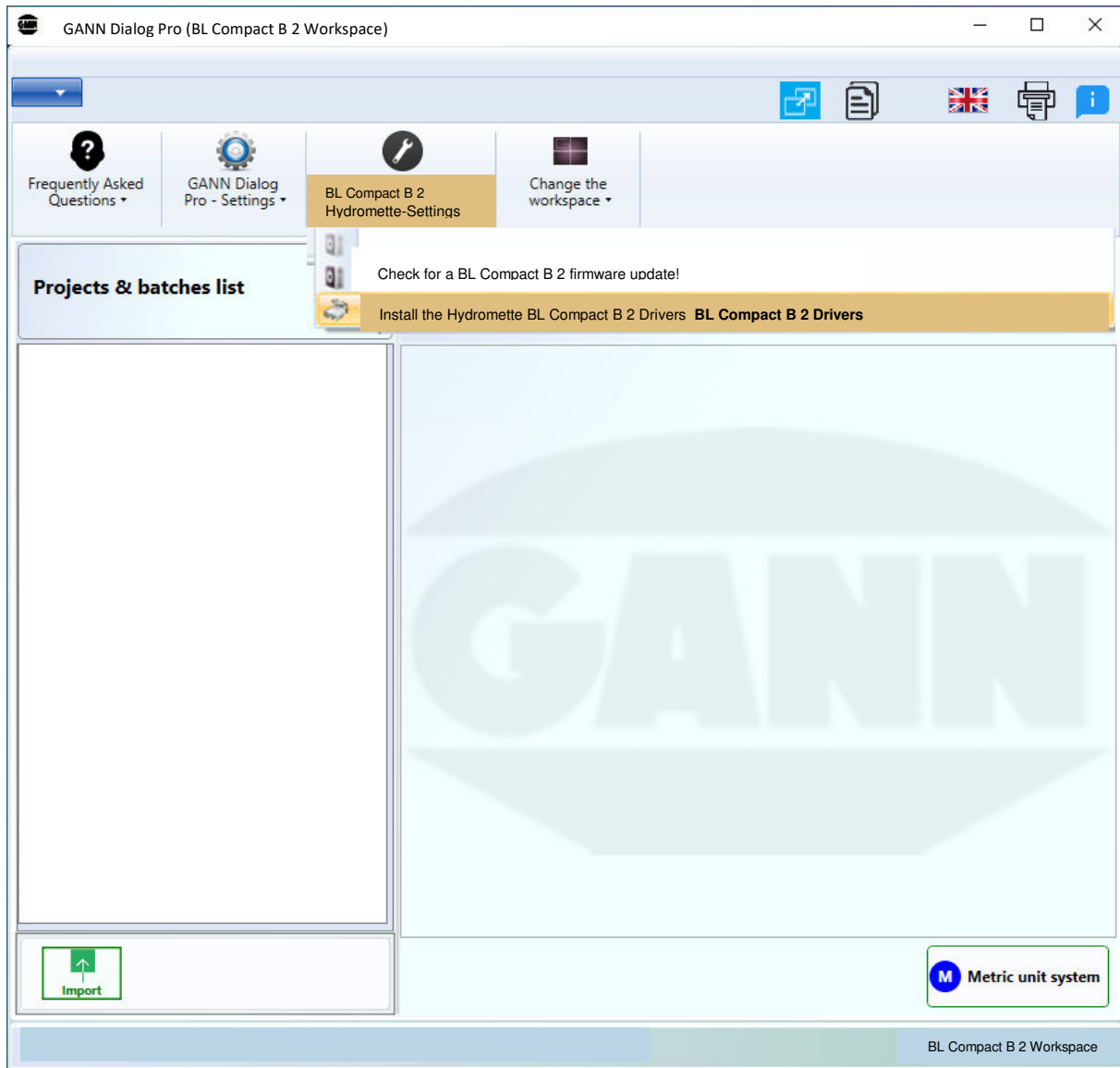

Figure_7_2: Download device drivers of the Hydromette BL Compact B 2

To download the device drivers, the working range of the desired Hydromette must first be selected in the menu item "Select working range".

8 USB-Communication with a PC

The software "GANN Dialog Pro" must be installed before the Hydromette BL Compact B 2 is connected to a PC (see chapter 7, [Figure 7-1](#)). GANN Dialog Pro includes the associated device drivers, which must also be installed (see chapter 7, [Figure 7-2](#))

If the Hydromette BL Compact B 2 is connected to a PC with Windows operating system when it is switched off, the Hydromette starts in USB mode. No measurements can be performed during the communication with the PC. The GANN Dialog Pro software now provides the possibility to update the firmware of the Hydromette BL Compact B 2 via the Internet. The Hydromette remains in USB mode after disconnecting the USB cable. The Hydromette will only restart in standard mode after it has been switched off and switched on again.

The USB connection must not be disconnected during the communication with the PC!



INFORMATION

If the connection is disconnected during a firmware update, the Hydromette BL Compact B 2 can no longer be started. In this case, the problem can be solved by reconnecting to a PC and installing the firmware. If it is not possible to install firmware on the device after several attempts, GANN Support must be contacted.

9 Application Notes

9.1 Comparative Measurement or Reference Measurement

With this type of measurement, almost all (set) building materials or mixed materials or mixed structures can be measured comparatively. It is important that these measurements are only carried out on the same materials or structures.

A deliberately dry spot must be determined on the structure to be measured. Select up to 5 measuring points within an imaginary square with a side length of approx. 20 cm. A dry sample of material with minimum dimensions of 20x20x5 cm can also be used as a reference. When measuring using a sample piece, it is important that this measurement is carried out on a non-conductive surface (e.g. polystyrene). The mean value is now to be calculated from these up to 5 measured values. This forms the reference value for the dry condition of the material or structure. Larger areas can thus be analysed using increased display values, e.g. with regard to the maximum moisture or the extent of moisture damage, and a two-dimensional moisture profile can be created. Drying progress can also be checked and observed by repeating measurements at defined measuring points.

When assessing the display values using the **capacitive measuring method**, it should be noted that metal in the substrate (iron armouring, cables, pipes, plaster rails, etc.) can lead to an increase in the measured value depending on the overlap height. Furthermore, it must be ensured that the minimum distances of 8–10 cm to corners, angles and edges are observed. Measurements in drilled holes or mortises are always incorrect measurements and cannot be used for assessment. Please note that digit measurements taken with devices with a measuring range of 0–100 digits and devices with a measuring range of 0–200 digits are not comparable.

When assessing the display values using the **resistance-based measuring method**, it is essential that you use suitable means to ensure that there are **no** electrical cables, water pipes or other supply lines in this location **before** drilling holes for probes or before knocking electrode pins into walls, ceilings, floors, etc.



INFORMATION

Digit readings obtained using the resistance-based measurement methods are not comparable with digit readings obtained using the capacitive measurement method.

Digit values are non-dimensional measured values and no real humidity values in per cent (%)! For this reason, the measured values are displayed in digits WITHOUT %!

9.2 General Notes on Structural Moisture Measurement

The structural moisture is mainly displayed in "digits" (depending on the device). Digit values are non-dimensional measured values and no real humidity values in per cent (%)! This can be used to measure almost all set building materials or mixed materials or mixed structures by comparative measurements within the same material or structure.

Pure building materials with corresponding characteristic curves are specified with weight percentages (wt. %) in relation to the dry weight or also in CM-% (moisture determination according to the calcium carbide method). Depending on the type of GANN Hydromette used, this is done using programmed characteristic curves or independent conversion using tables.

If a material is in a certain ambient climate for a longer period of time, it takes on a moisture content corresponding to this climate, which is also referred to as equilibrium moisture or practical moisture content. On reaching the equilibrium moisture content, the material no longer loses moisture if the surrounding climate remains the same and also no longer absorbs any moisture. The equilibrium values generally mentioned refer to a climate of 20 °C and 65 % relative humidity. However, these values must not be confused with the values at which the material can be worked or processed.

Floor coverings and paints must be considered and assessed in conjunction with the diffusion capacity of the material used. For example, when laying a PVC floor covering, the subsequent average levelling moisture content must be taken as a basis, i.e. in a centrally heated room with an anhydrite screed, installation should wait until a moisture content of approx. 0.6 % by weight has been reached. In contrast, wood parquet flooring can be laid on a cement screed with normal stove heating at a moisture content of 2.5 - 3.0 % by weight.

The respective long-term ambient climate must also be taken into account when assessing **wall surfaces**. The lime mortar plaster in an older vaulted cellar may well contain a moisture content of 2.6 % by weight, but a gypsum plaster in a centrally heated room would have to be labelled as too damp from a moisture content of 1.0 % by weight.

When evaluating the moisture content of a material, the surrounding climate is the primary consideration. All materials are subject to continuously changing temperatures and air humidity. The influence of the material moisture depends significantly on the heat conductivity, the thermal capacity, the resistance to water vapour diffusion and the hygroscopic properties of the material.

The "target humidity" of a material is the humidity that corresponds to the mean value of the equilibrium humidity under changing climatic conditions to which it is constantly exposed. The humidity values in living spaces in Central Europe are approx. 45 - 65 % R.H. in summer and approx. 30-45 % R.H. in winter. These fluctuations can cause damage in centrally heated rooms in winter.

It is not possible to lay down generally applicable values. Much more it always requires the technical and expert experience to correctly evaluate the measured values.

Different building materials, such as clay building materials, etc. cannot be measured with the usual accuracy due to their different mineral admixtures or burning times. However, this does not mean that comparative measurements in the same building material and on the same object are not meaningful. Different display values can be used, for example, to localise the extent of a moisture

field (water damage), or comparative measurements on dry interior walls and damp exterior walls can be used to determine progress in drying out.

Attention:

The notes and tables in these operating instructions on permitted or normal humidity conditions in practice and the general definitions of terms have been taken from the specialist literature. No responsibility can therefore be assumed by the manufacturer of the measuring instrument for the correctness of this information. The conclusions to be drawn from the measurement results are related to the individual conditions and the knowledge from professional experience for each user.

9.3 Notes on non-destructive Structural Moisture Measurement

The non-destructive structural moisture measurement is based on an electrical capacitance determination depending on the dielectric constant (DK) of the measurement object. During the measurement, water molecules are polarised by applying an electric field. The dielectric constant of water is very high compared to the building material and therefore determines the measurement result.

The measuring field is formed between the active sphere on the top of the device and the substrate mass to be analysed. The change in the electric field caused by the material and moisture is recorded and shown digitally on the display of the measuring device.

The bulk density of the building material has a measurable influence on the measured variable. With a higher bulk density, a higher dielectric constant is to be expected.

It is only possible to draw conclusions about the absolute moisture content in per cent by weight or the moisture content in per cent CM if the drying process is normal. If the building material dries out too quickly (e.g. due to warm air, dehumidifiers, underfloor heating, etc.), the measured values may be too low due to the low surface moisture.

It is difficult to make a generally valid statement on the accuracy of measurement in relation to weight or mass percentages. Pure building materials with specific characteristic curves can be measured with good accuracy, whereas mixed masonry and laminates made of different materials are less accurate. However, exact percentages are often not necessary and so-called comparative measurements are completely sufficient.

The following points must also be observed for capacitive measurement:

- Capacitive measuring devices are moisture indicators and not measuring devices with 100 % reliable measured value statements.
- The conversion tables or characteristic curves for capacitive measuring devices generally refer to pure building materials (not to layered building materials, e.g. plaster on masonry etc.).

- The measurement results obtained with the capacitive measuring devices alone are not reliable or sufficient for expert reports. The measurement results should always be backed up by a second measurement method (e.g. resistance or CM measurement).
- There are no exact values for the penetration depth. The depth effect depends, among other things, on the bulk density, the current moisture content, the roughness of the surface, the pore size and quantity and the moisture distribution in the material. Therefore, no binding statements can be made in this regard.

Of course, this problem does not only apply to capacitive measuring instruments from GANN, but is the physical basis for all moisture probes and sensors that work dielectric constant (DK), high-frequency or microwave basis.

9.4 Using the Hydromette BL Compact B 2

To prevent any influence from the hand of the operator who is performing the measurement, during the measurement and inspection process, only the rear half can be covered by the hand. The front half (display/ball) of the device must remain free.

Correct handling of the device:

While measuring, always grip the device by the lower end of its housing.



Figure 9-1: Correct device position

Improper handling of the device:

During measurement, the hand influences the measurement field of the ball electrode and thereby changes the measurement value, as shown.



Figure 9-2: Improper device position

Measuring:

Press the measurement button "**M**" for longer than 2 seconds, and scan the area to be inspected. The electrode must rest firmly on the building material and be held as vertically as possible (approx. 90°) to the area. A measuring process is carried out as long as the measurement button is pressed. After releasing the "**M**" button, the measuring process is interrupted and the "**Hold**" symbol is displayed.



Figure 9-3: Measuring as vertically as possible to the measurement area

Measurements in drill holes lead to faulty measurements. This results in an overlay of the measuring field and thus an increase in the measured value.

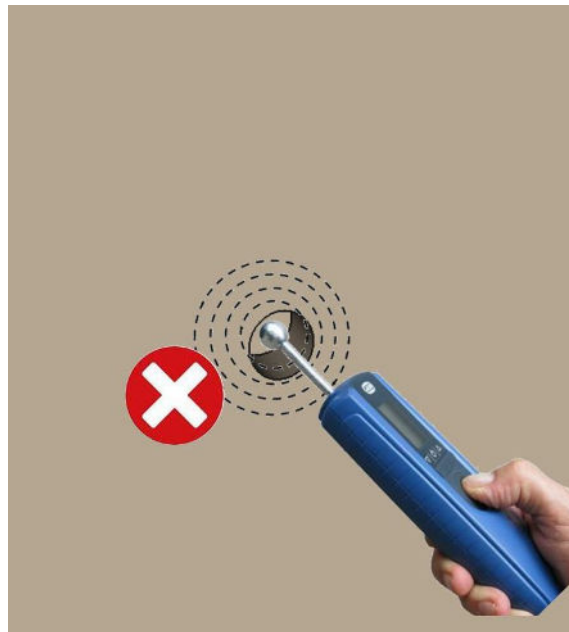

Figure 9-4: Incorrect use – measurement in drill hole

In the corner/angle area, it is essential to maintain a distance of approx. 8 - 10 cm from the edge/angle.

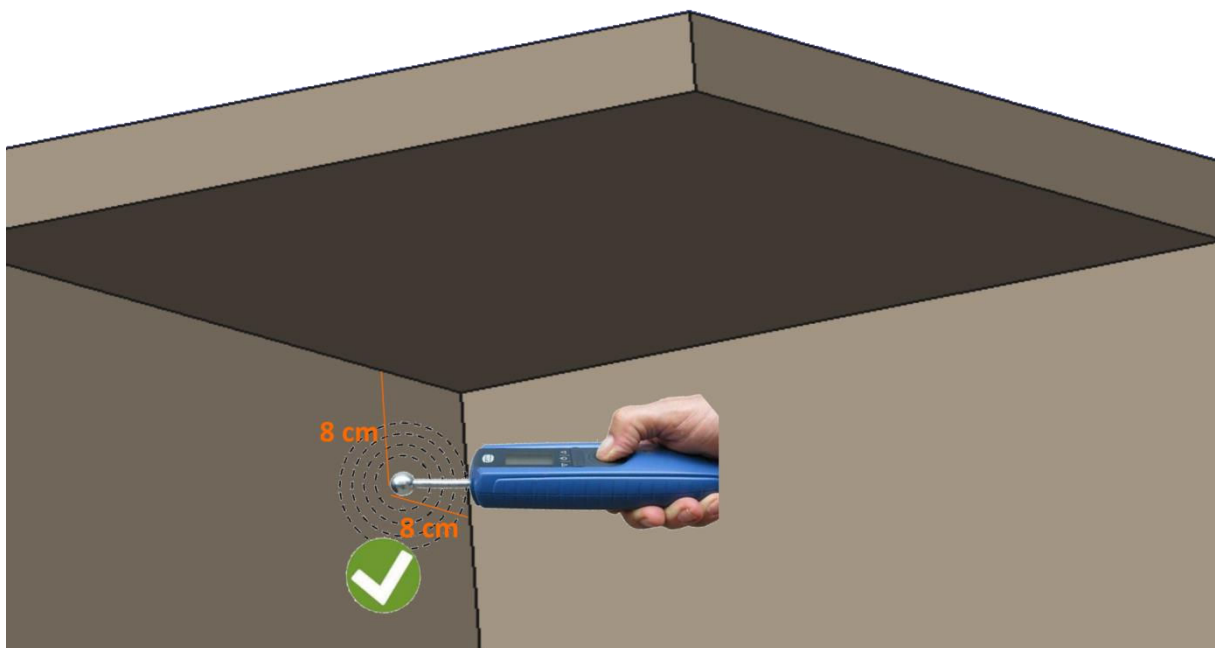

Figure 9-5: Correct use of distances when measuring

Measurements directly in the corner/angle area lead to an overlapping of the measuring field and thus change the measured value!



Figure 9-6: Incorrect use in corner/angle area

9.5 Display Values (Digits) in Relation to the Bulk Density

| Density of the building material kg/m ³ | Corresponding relative humidity in % | | | | | |
|---|---|------------|----------|----------|------------|-----------|
| | 30-----50-----70-----80-----90-----95-----100 | | | | | |
| | Display in Digits* | | | | | |
| | very dry | normal dry | semi dry | moist | very moist | wet |
| up to 600 | 10 - 20 | 20 - 40 | 40 - 60 | 60 - 90 | 90 - 110 | above 110 |
| 600 - 1200 | 20 - 30 | 30 - 50 | 50 - 70 | 70 - 100 | 100 - 120 | above 120 |
| 1200 - 1800 | 20 - 40 | 40 - 60 | 60 - 80 | 80 - 110 | 110 - 130 | above 130 |
| above 1800 | 30 - 50 | 50 - 70 | 70 - 90 | 90 - 120 | 120 - 140 | above 140 |

* Digital values are dimensionless measurement values and not real moisture values as a percentage!

Figure 9-7: Display values as a function of the material bulk density

9.6 Orientation Values

The following data serves as an orientation guide for anticipated display values:

Residential spaces

| | |
|-------|-----------------|
| dry | 20 - 40 Digits |
| moist | 80 - 140 Digits |

Cellars (old buildings)

| | |
|-------|------------------|
| dry | 40 - 60 Digits |
| moist | 100 - 150 Digits |



INFORMATION

Dew point undershoots or condensation on the surface to be measured can cause higher display values and thus make the wall appear more humid than is actually the case! It is therefore always advisable to carry out an additional indoor climate measurement and dew point calculation (Hydromette BL Compact TF-IR 2, TF 3 & RH-T). This can prevent misinterpretations. If readings exceed 130 digits, condensation may already be starting to form, depending on the bulk density.

Depending on the height of the covering, metal in the subsurface (iron reinforcements, wires, pipes, stucco bars, etc.) can raise the measurement value. This should be considered when evaluating the displayed values in relation to the covering.

10 Accessories

Connection cable MK 26 – Length: 1.80 m (order no. 31016920)



For device connection with a USB port.

11 Appendix

11.1 Material Table

| Material index | Material |
|----------------|-------------------------------|
| 0 | Scan mode (display in digits) |
| 11 | Cement screed in weight-% |
| 12 | Anhydrite screed in weight-% |
| 13 | Concrete in weight-% |
| 14 | Cement mortar in weight-% |
| 15 | Lime mortar in weight-% |
| 16 | Mixed plaster in weight % |
| 17 | Gypsum plaster in weight % |
| 18 | Cement screed in CM % |
| 50 | Anhydrite screed in CM % |
| 54 | Gypsum plaster in CM % |
| 55 | Lime mortar in CM % |
| 58 | Cement mortar in CM % |
| 72 | Mixed plaster in CM % |
| 73 | Concrete in CM % |

11.2 Display Values (Digits) by Weight Percentage or CM Percentage

| Display in Digits | | 40 | 50 | 60 | 70 | 80 | 90 | 100 | 110 | 120 | 130 |
|------------------------------------|-------|-----|-----|-----|-----|-----|-----|------|------|-----|-----|
| Cement screed | wt.-% | 1.8 | 2.2 | 2.7 | 3.2 | 3.6 | 4.1 | 4.5 | 5.0 | 5.5 | 5.9 |
| | CM-% | 0.7 | 1.0 | 1.4 | 1.8 | 2.1 | 2.5 | 2.9 | 3.2 | 3.6 | 4.0 |
| Anhydrite screed | wt.-% | 0.1 | 0.3 | 0.6 | 1.0 | 1.4 | 1.8 | 2.2 | 2.5 | 2.9 | 3.3 |
| | CM-% | 0.1 | 0.3 | 0.6 | 1.0 | 1.4 | 1.8 | 2.2 | 2.5 | 2.9 | 3.3 |
| Concrete C12/15, C20/25, C30/37 | wt.-% | | 1.3 | 1.9 | 2.5 | 3.2 | 3.8 | 4.4 | 5.0 | 5.6 | 6.2 |
| | CM-% | | 0.3 | 0.8 | 1.3 | 1.7 | 2.2 | 2.7 | 3.2 | 3.7 | 4.2 |
| Cement mortar | wt.-% | 1.8 | 2.7 | 3.5 | 4.6 | 6.0 | 7.0 | 7.8 | | | |
| | CM-% | 0.6 | 1.5 | 2.3 | 3.1 | 4.0 | 4.8 | 5.6 | | | |
| Lime mortar | wt.-% | 0.6 | 2.0 | 3.3 | 4.5 | | | | | | |
| | CM-% | 0.6 | 2.0 | 3.3 | 4.5 | | | | | | |
| Lime cement mortar | wt.-% | 2.2 | 3.6 | 5.0 | 6.4 | 7.8 | 9.2 | 10.6 | 11.0 | | |
| | CM-% | 1.5 | 2.7 | 4.0 | 5.2 | 6.4 | 7.6 | 8.8 | 10.0 | | |
| Gypsum plaster | wt.-% | 0.3 | 0.5 | 1.0 | 2.0 | 3.5 | 6.5 | 10.0 | | | |
| | CM-% | 0.3 | 0.5 | 1.0 | 2.0 | 3.5 | 6.5 | 10.0 | | | |

11.3 General Concluding Remarks

The notes and tables in these operating instructions on permitted or normal humidity conditions in practice and the general definitions of terms have been taken from the specialist literature. No responsibility can therefore be taken by the manufacturer of the measuring device for the correctness of this information.

The conclusions to be drawn from the measurement results are related to the individual conditions and the knowledge from professional experience for each user. In cases of doubt, for example concerning the permitted moisture content in coating or screed substrates when laying floor coverings, it is recommended to contact the manufacturer of the coating or floor covering and to take account of the recommendations of trade organisations.

Please note:

The instructions for use for the device and any accessories should be carefully observed, as supposed simplifications in handling often lead to measurement errors.

- Subject to technical changes-

Status: July 2024



GANN MESS- U. REGELTECHNIK GMBH

70839 GERLINGEN SCHILLERSTRASSE 63 INTERNET: <http://www.gann.de>

Verkauf National: TELEFON 071 56-4907-0 TELEFAX 071 56-4907-40 E-MAIL: verkauf@gann.de

Verkauf International: TELEFON +49-71 56-4907-0 TELEFAX +49-71 56-4907-48 E-MAIL: sales@gann.de

12 EU Declaration of Conformity



Document no. / order no.: 30012032

Product identifier: **HYDROMETTE BL Compact B 2**

We declare that the hand-held meter and related accessory correspond with the protection requirements and if used according to their intended purpose, comply with the requirements of the directives:

2014/30/EU EMC Directive

2011/65/EU RoHS

Applied harmonized standards:

EN 61326-1 : 2013 General EMC requirements

EN IEC 63000 : 2018 Restriction of hazardous substances

This declaration is given in responsibility for:

Gann Mess- und Regeltechnik GmbH

Schillerstr. 63

70839 Gerlingen

Germany

issued by:

name: Michael Gann

Position in the company of manufacturer: Managing Director

Place / date: Gerlingen, 12 December 2024



(Legally valid signature)